

Schema di montaggio

Art. CA 1477

fimar
group

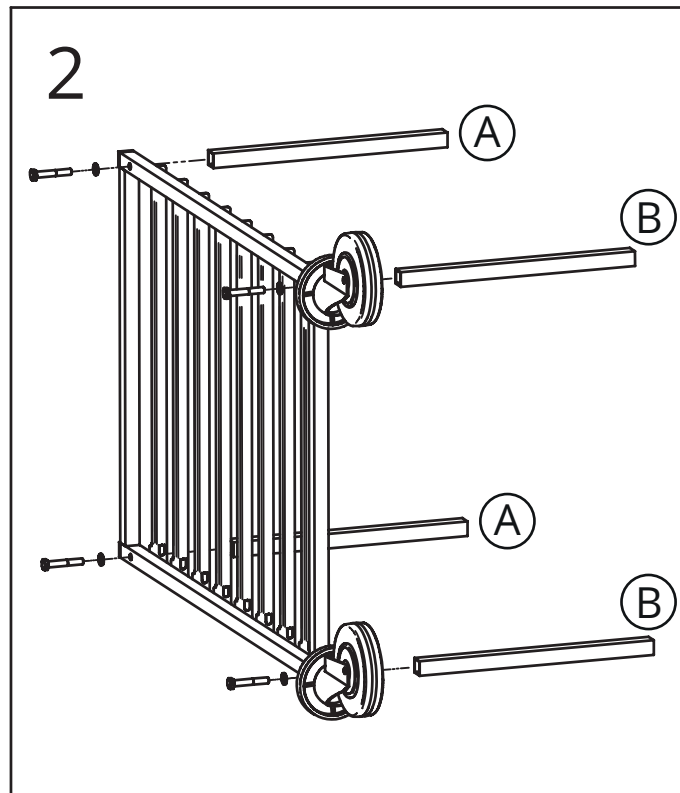
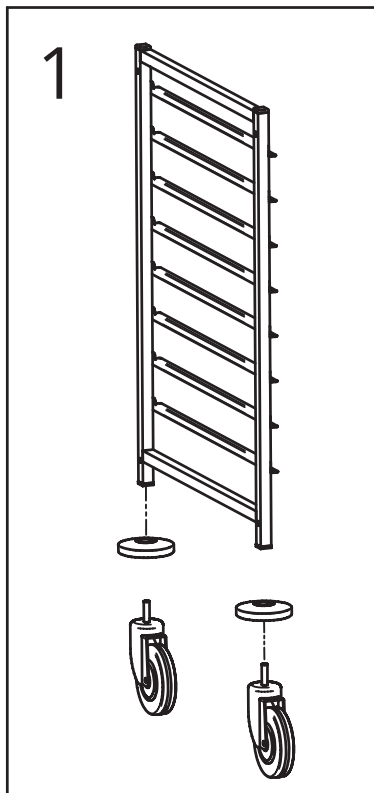

ISTRUZIONI / INSTRUCTIONS:

Montare prima i traversi superiori (A), proseguendo poi con i traversi inferiori (B), come in figura.

Assemble the upper cross-pieces first (A), after with the lower cross-pieces (B), as shown in the figure.

