

EXPLOSIONSZEICHNUNG

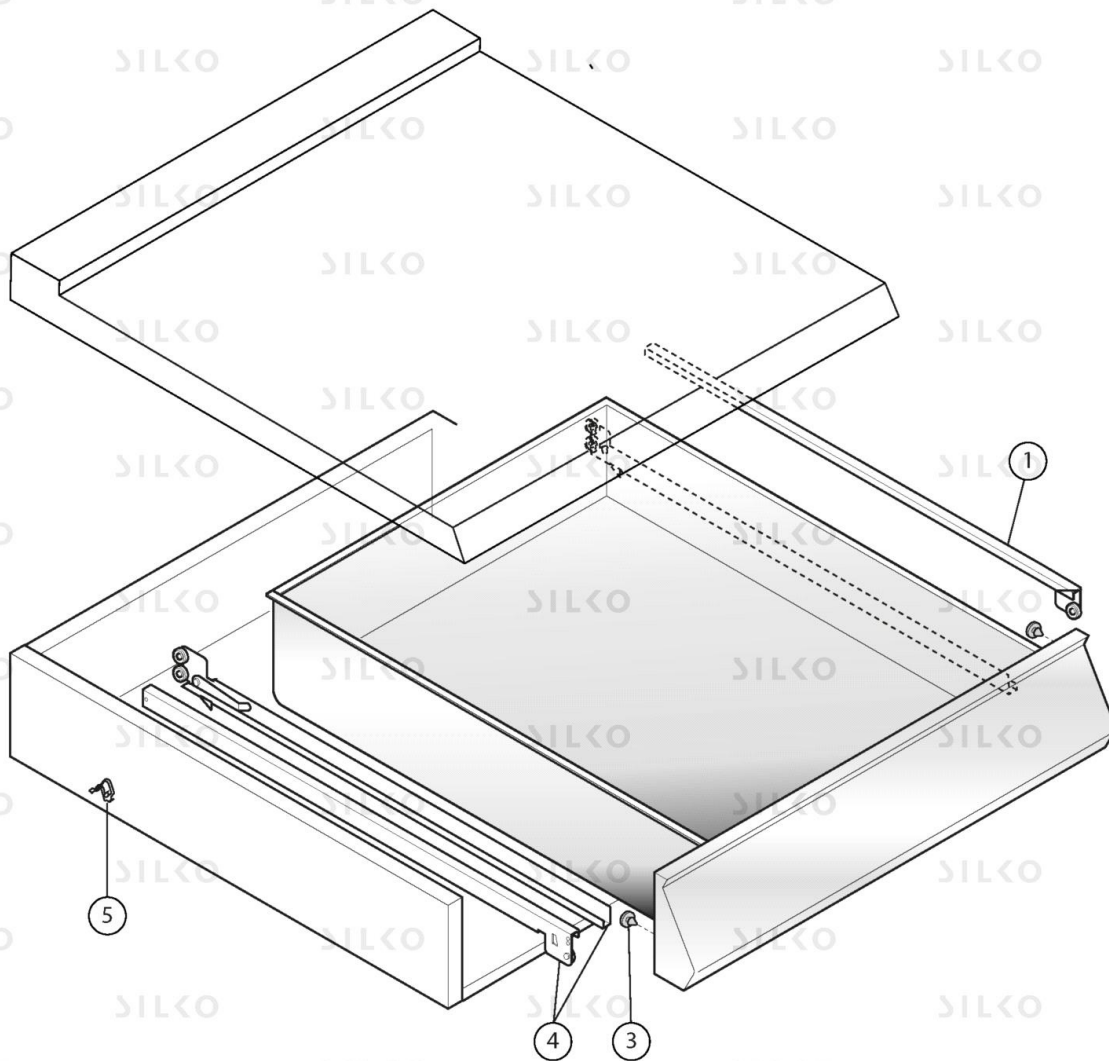

KBS Gastrotechnik GmbH – Schoßbergstraße 26 – 65201 Wiesbaden



NEEN74GC

descrParent

Pos	Art.- Nr.	Bezeichnung
0001	MA1031006100	RECHTE SCHIENE [C] L. 525
0003	MA9003000300	PRELLVORRICHTUNG [C]
0004	MA1031006200	LINKE SCHIENE [C] L. 525
0005	MACM140300	FEDER [C] KUPPLUNG TOPS